



# Architectural Canopy Cantilever

## PRODUCT INFORMATION

Experience excellence with our top-quality extruded aluminum canopies. Minimalistic design for unobstructed coverage, creating a spacious and inviting building entry.



# Architectural Canopy Cantilever

## TECHNICAL DATA

Most Extruded Aluminum (T6-6063)

Fascia .125"

Deflection rating L/180.

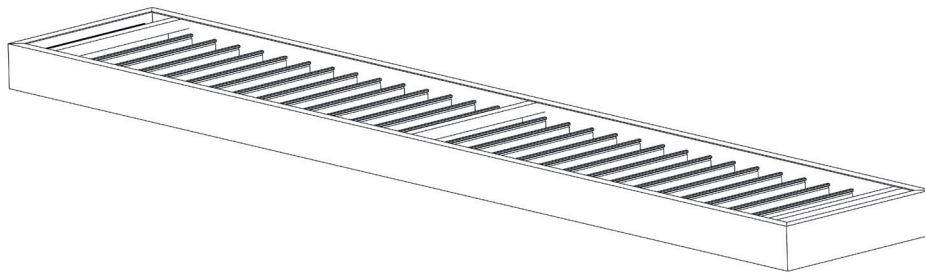

GUTTER FASCIA

## Fascia Options

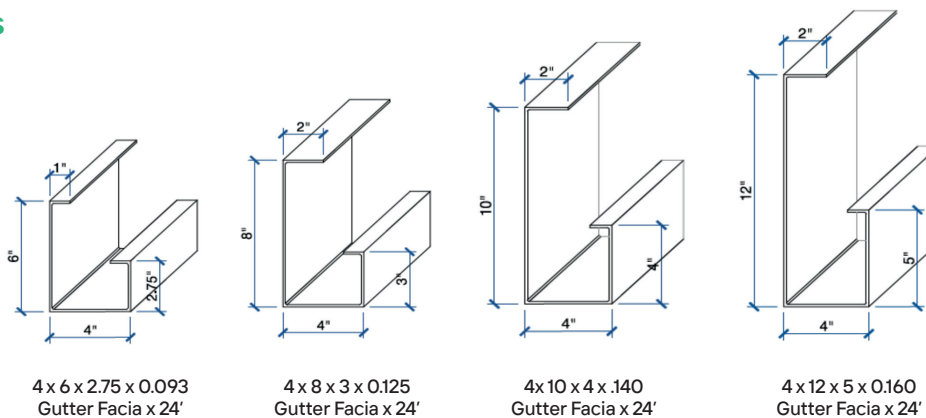

## FLAT SOFFIT DECKING

Decking consists in interlocking extruded aluminum members with mechanical fasteners field applied to provide structural integrity for the completed assembly.

Front View

Top View

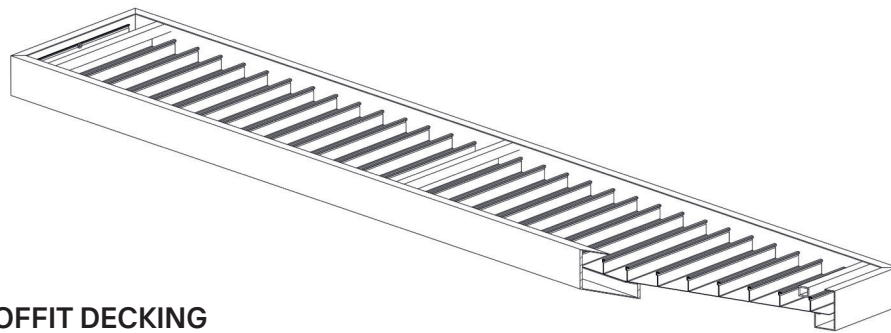
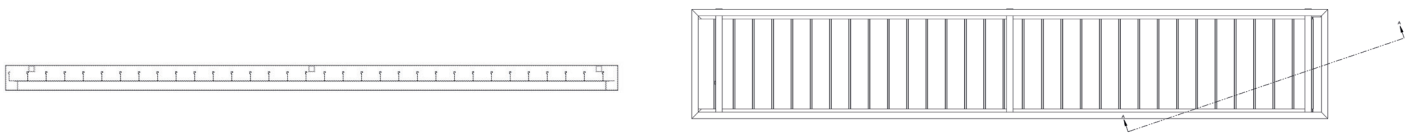

**FLAT SOFFIT DECKING**

## Deck Options

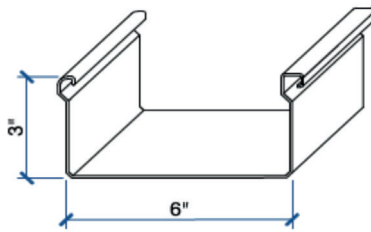

3 x 6 x 0.065 Self Mating  
Canopy Roof Pan x 24'

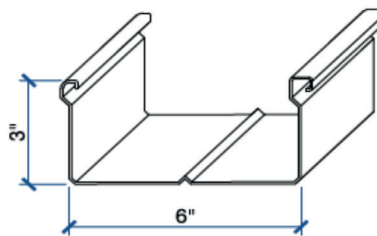

3 x 6 x 0.078 Self Mating  
Canopy Roof Pan (V-Deck)

## SUPPORT SYSTEM

Connections are mechanically assembled utilizing 3/16" fasteners with a minimum shear stress of 350 lb.

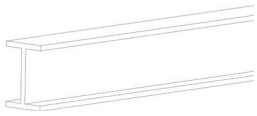

### S3 x 5.7# Structural Steel S-Beam

ASTM A36 grade material.  
Weight of the beam is 5.7 pounds per foot.  
The flange is 2.60" wide.  
The web is 0.17" thick at the thinnest point

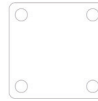

### 7" x 8" x 1/2" Steel Plates

ASTM A36 grade material.  
High quality laser cut hot rolled mild steel



## CONCEALED DRAINAGE

Water will drain from covered surfaces into the integral fascia gutter and be directed to either the front or the rear for discharge via its designated downspout.

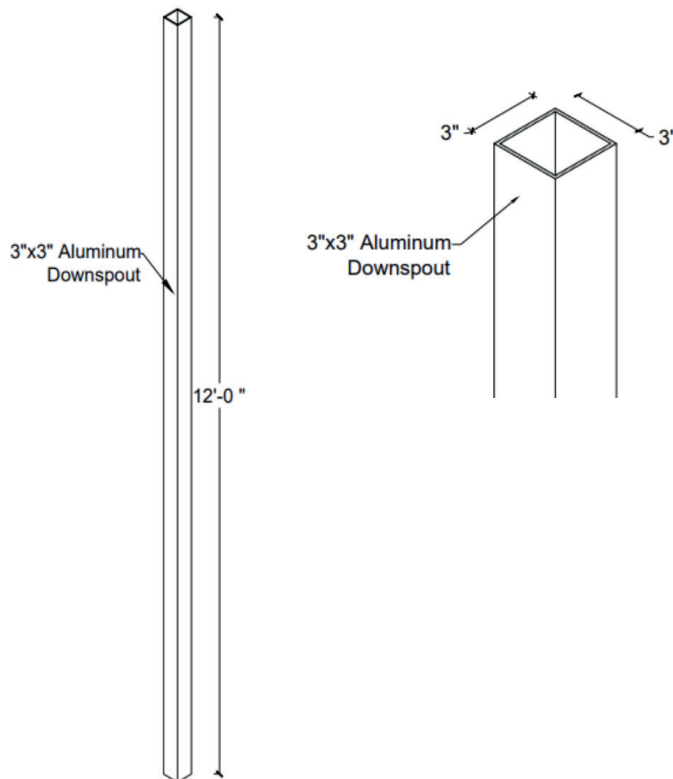



# Architectural Canopy With Hanger Rods

## PRODUCT INFORMATION

Experience excellence with our top-quality extruded aluminum canopies. Featuring a unique built-in drainage system, these lightweight canopies offer a contemporary facelift for your exterior while providing essential sun, rain and snow protection



# Architectural Canopy With Hanger Rods

## TECHNICAL DATA

Most Extruded Aluminum (T6-6063)  
Fascia .125"  
Deflection rating L/180.

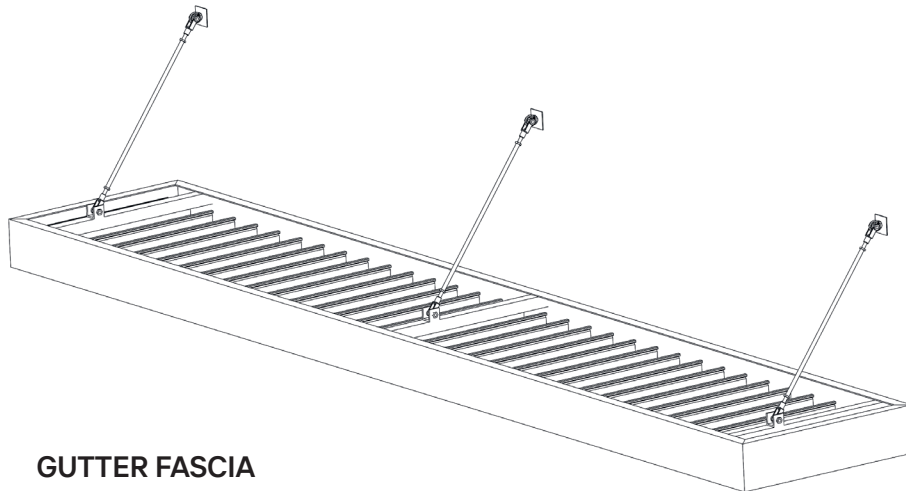

GUTTER FASCIA

## Fascia Options

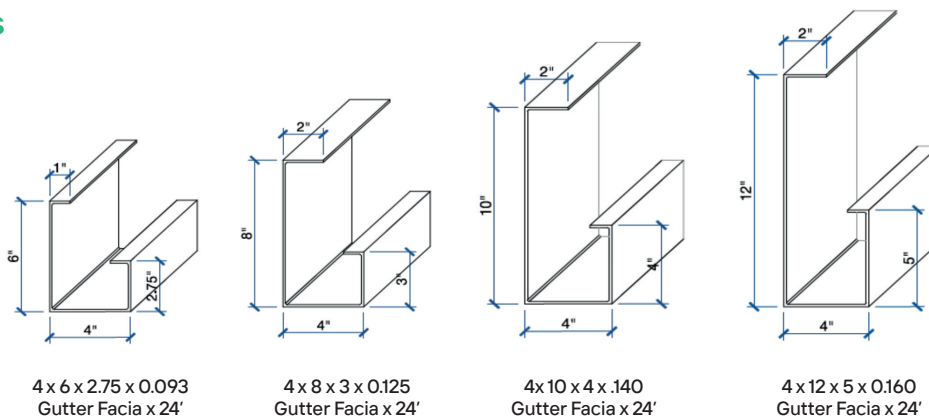

## FLAT SOFFIT DECKING

Decking consists in interlocking extruded aluminum members with mechanical fasteners field applied to provide structural integrity for the completed assembly.

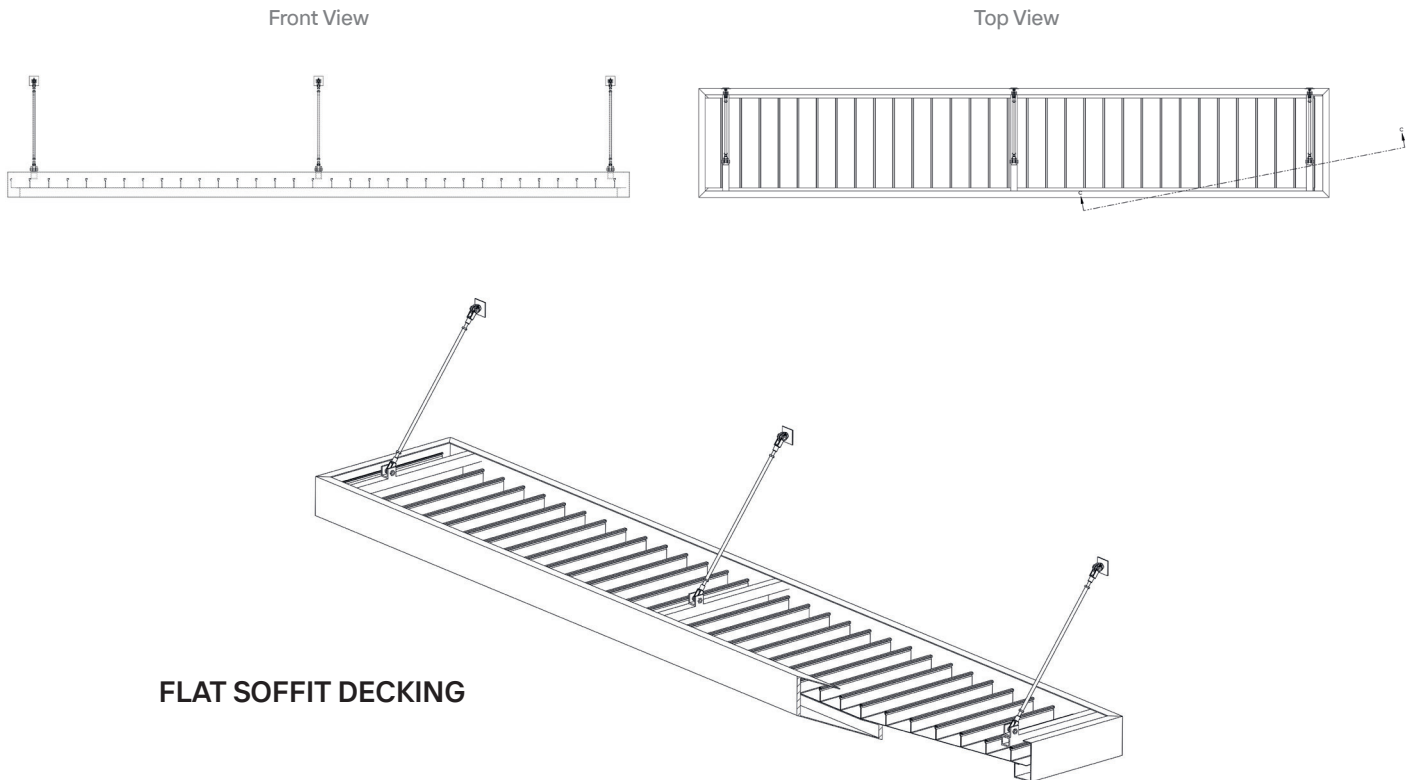

**FLAT SOFFIT DECKING**

## Deck Options

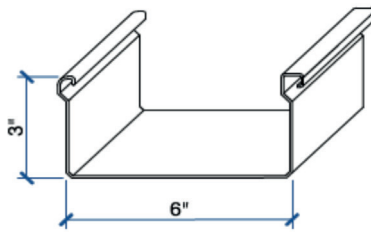

3 x 6 x 0.065 Self Mating  
Canopy Roof Pan x 24'

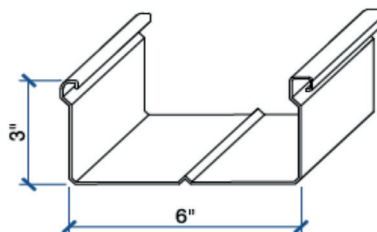

3 x 6 x 0.078 Self Mating  
Canopy Roof Pan (V-Deck)

## SUPPORT SYSTEM

Connections are mechanically assembled utilizing 3/16" fasteners with a minimum shear stress of 350 lb.

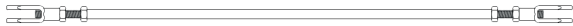

Hanger rods made of 1/2" galvanized steel threaded rod with a 1" OD aluminum round sleeve (.250 walls) and adjustable jaw ends.



2" x 2" x 1/4" square aluminum tube integrated into the canopy to provide support to the hanger rods.

## CONCEALED DRAINAGE

Water will drain from covered surfaces into the integral fascia gutter and be directed to either the front or the rear for discharge via its designated downspout.

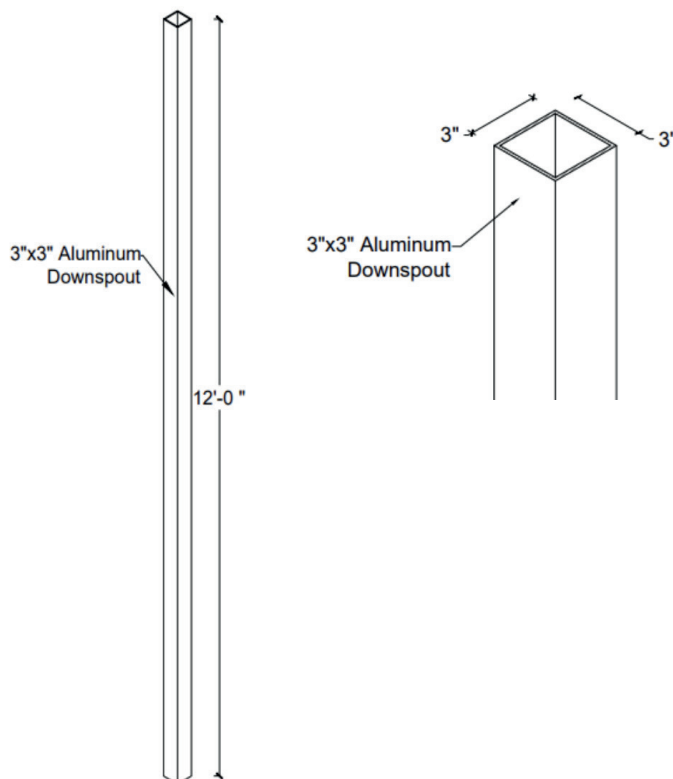



# Architectural Sunshades

## PRODUCT INFORMATION

Experience excellence with our top-quality architectural sunshades. Engineered to reduce heat, maximize natural light, and shield your space from harmful UV rays.



# Architectural Sunshades

## APPLICATIONS

Door and window covers    Store fronts  
Loading docks                Shopping enters  
Parking garages

## BLADES AND BULLNOSES

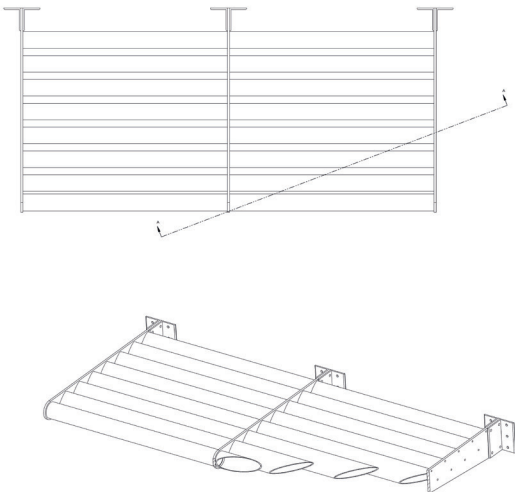

### **BULLNOSES:**

Explore our selection of premium Bullnoses, available in three elegant options: Half round, Full round, and Rectangular Tube, to elevate the aesthetic appeal of your project.

### **AIRFOIL BLADES VARIETY:**

Select from a range of Airfoil Blade options, spanning sizes from 2 inches to 12 inches, to suit your specific requirements.

## OUTRIGGERS

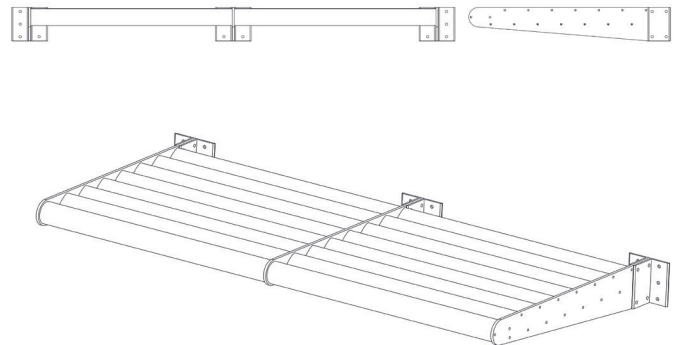

Discover our versatile Outriggers, featuring a choice of Rectangular Bars, Rectangular Tubes, or Plates meticulously designed with precision-cut holes, ready to seamlessly accommodate and enhance your blade attachments

## MATERIALS



### 6" x 6" 1/4" Flat Base Plates

Designed for use in trades and job sites.  
Weather resistant to withstand rough outdoor work conditions.  
Made of heavy-duty steel for durability.

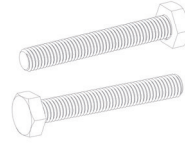

### 1/2" x 3" Ø Through Bolt

Secures metal without pre-drilling.  
Fast and easy installation.  
Protects the job's appearance.  
Many dimensions available.

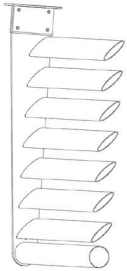

### Standard Framing

Rectangular tube frames (mitered for welding).  
Aluminum pre-punched rectangular tubes for side frames and center mullion.  
Air Foil Louver Blades.

## AIR FOIL OPTIONS

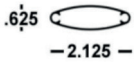

**2-1/8" Air Foil x 16'**  
56-63-200 Wall: .045  
uses #14 screw

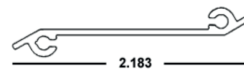

**2" Solid Blade x 20'** uses #8 screw  
52-63-4696 Mill Finish  
52-63-3060 White

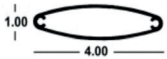

**4" Air Foil x 24'**  
56-63-400 Wall: .080  
uses #14 screw

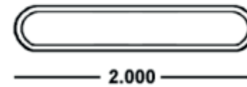

**2" Hollow Blade x 16'**  
41-63-830 Mill Finish

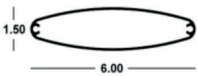

**6" Air Foil x 24'**  
56-63-600 Wall: .100  
52-63-1020 (MO) Wall: .100  
uses #14 screw

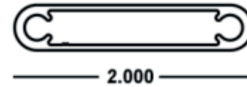

**2" Hollow Blade x 16'** uses #14 screw  
80-MF-013 Mill Finish



**8" Air Foil x 24' (2 screw bosses)**  
56-63-400 (TX/MO) Wall: .110  
uses #14 screw



**10" Air Foil**  
MILL ORDER 56-63-1000 Wall: .125  
uses #14 screw



**12" Air Foil**  
MILL ORDER 52-63-11852 Wall: .125  
uses #14 screw



# Stationary Fabric Awnings

## PRODUCT INFORMATION

A durable, weather-resistant extension that features a timeless design and adds unique aesthetic appeal.

# Stationary Fabric Awnings

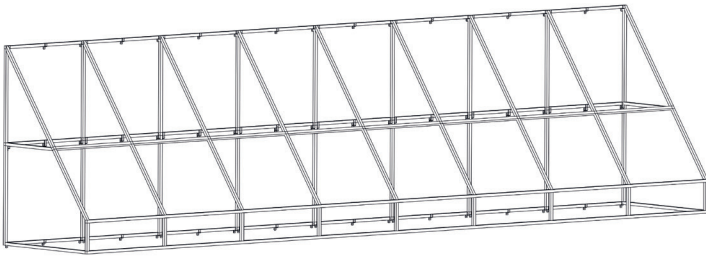

## STATIONARY FABRIC AWNINGS

### MATERIALS

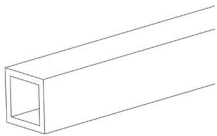

#### 1" X 1" x 24' Aluminum Square Tube

Rounded corners to assure fabric lasts longer.  
Aluminum alloy 6063-T5.  
Smooth sides and strong welds.  
Provides resistant framing and low maintenance.

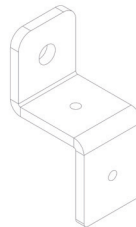

#### Aluminum Z Bracket

Tight dimensional tolerances.  
Good for mounting application.  
Excellent performance in vertical.

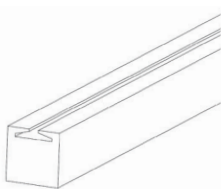

#### 1" x 1" x 24' Staple In Channel

Rounded corners to assure fabric lasts longer.  
Aluminum alloy 6063-T5.  
Smooth sides and strong welds.  
Provides resistant framing and low maintenance.

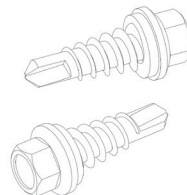

#### TEK #10 Screws

Secures metal without pre-drilling.  
Fast and easy installation.  
Protects the job's appearance  
Many dimensions available.



## FABRIC OPTIONS

### Acrylic Fabric

100% solution dyed acrylic  
UV and Fade Resistant  
Water and Mildew Repellent.  
Stain resistant  
Breathable to prevent condensation.  
Minimal Shrinking or stretching  
Stain resistant  
Heat Sealable  
Finish/Coating: Fluorocarbon  
10-year limited warranty

### Fire Retardant Fabric

Flame and UV Resistant.  
Highly water repellent and soil/stain  
release finish.  
Flexible in hot and cold conditions.  
5-year warranty.  
Weight: 8.75 oz/sq. Yard  
Mildew Resistant  
Available in 18 colors and patterns.

### Backlit Vinyl Fabric

Base fabric: Polyester, Woven, Vinyl  
Coated.  
High Tear and Tensile strength for  
maximum performance.  
Soft and flexible material.  
Water and Mildew Repellent.  
Heat Sealable and Weldable.  
Printable and Accepts PSA Films.  
Flame Resistance. Meets C.S.F.M NFPA 701  
Available in 18 brilliant colors.  
Weight: 15 oz./sq. yard.  
5-year limited warranty.

## OTHER OPTIONS

### Solid Polycarbonate

1 Side UV Protected  
Water resistant  
Maintenance Free  
Long lasting material  
Available in solid and textured finish  
Available Clear and in 4 more colors.



# Standing Seam Awnings

## PRODUCT INFORMATION

Standing seam metal roofing is one of the most durable and weather-tight roof systems available in the industry. With concealed fasteners and no nail holes, it ensures lasting protection against the elements.



# Standing Seam Awnings

Humidity Resistance.  
Water Immersion Resistance.  
Chemical Resistance.  
Impact Resistance.  
High Temperature Resistance.

## MATERIALS

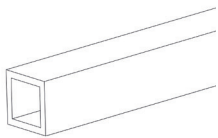

### 1" X 1" x 24' Aluminum Square Tube

Rounded corners to assure fabric lasts longer.  
Aluminum alloy 6063-T5.  
Smooth sides and strong welds.  
Provides resistant framing and low maintenance.

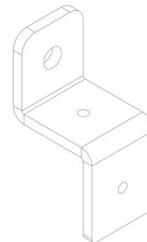

### Aluminum Z Bracket

Tight dimensional tolerances.  
Good for mounting application.  
Excellent performance in vertical.

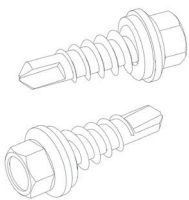

### TEK #10 Screws

Secures metal without pre-drilling.  
Fast and easy installation.  
Protects the job's appearance  
Many dimensions available.

## FINISHES

PVDF Kynar500® or Hylar5000®.  
Standard and Premium Colors Available.  
Custom Colors are available upon request.

## METAL ROOFING, WALL, AND PERIMETER EDGE FINISHES

### QUICK-SHIP STOCKING COLORS

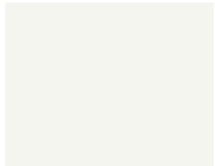

BONE WHITE



SIERRA TAN



MEDIUM BRONZE



ANTIQUÉ BRONZE

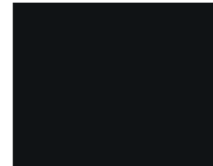

TRADITIONAL BLACK *L*



CITYSCAPE



SLATE GRAY



MUSKET GRAY



IRON ORE



SILVER

*P*



WEATHERED ZINC *P*

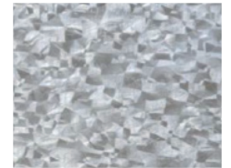

DREXLUME™

*M*

### SPECIAL ORDER COLORS



SANDSTONE

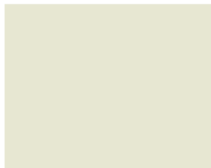

ALMOND



BUCKSKIN



MANSARD BROWN



GRANITE *L*



CHARCOAL



HEMLOCK GREEN



PATINA GREEN



FOREST GREEN



HARTFORD GREEN

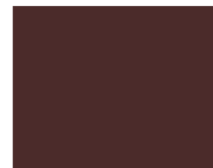

BURGUNDY



COLONIAL RED



TERRA COTTA



CARDINAL RED



MILITARY BLUE



PACIFIC BLUE



INTERSTATE BLUE



AWARD BLUE



CHAMPAGNE

*P*



COPPER PENNY

*P*



AGED COPPER

*P*

*P* = PREMIUM

*M* = MILL FINISH

*L* = LOW GLOSS COLOR

• = Standard Product

✓ = CRRC Approved Finishes

Product Options	SR	SRI	24 ga x 20"	24 ga x 48"	22 ga x 48"	26 ga x 20"	26 ga x 27.5"	26 ga x 48"	0.032 x 20"	0.032 x 48"	0.040 X 48"	0.050 x 48"	0.063 x 48"	Cool Roof Rated
<b>Standard Colors</b>														
Almond	0.53	62	•	•	•					•	•	•		✓
Antique Bronze	0.29	28	•	•	•		•		•	•	•	•		
Traditional Black	0.20	17	•	•	•		•		•	•	•	•	•	
Bone White	0.67	81	•	•	•	•		•	•	•	•	•	•	✓
Buckskin	0.38	41	•	•					•	•				
Burgundy	0.24	23	•	•						•		•		
Charcoal	0.27	27	•	•					•	•	•	•		✓
Cityscape	0.44	49	•	•	•				•	•	•	•		✓
Colonial Red	0.32	34	•	•			•		•	•	•	•		✓
Forest Green	0.10	6	•	•	•		•		•	•	•	•		
Hartford Green	0.29	29	•	•						•	•	•		
Hemlock Green	0.29	29	•	•						•		•		✓
Interstate Blue	0.13	8	•	•					•	•		•		
Iron Ore	0.27	26	•	•			•		•	•	•	•		
Mansard Brown	0.29	29	•	•	•				•	•	•	•		✓
Medium Bronze	0.26	26	•	•	•		•		•	•	•	•	•	✓
Midnight Bronze	0.06	0	•	•							•			
Military Blue	0.29	29	•	•					•	•				✓
Musket Gray	0.31	32	•	•	•				•	•		•		✓
Pacific Blue	0.25	24	•	•					•	•				✓
Patina Green	0.33	34	•	•					•	•				✓
Sandstone	0.49	56	•	•	•				•	•	•	•	•	✓
Sierra Tan	0.36	39	•	•	•				•	•	•	•		✓
Slate Gray	0.37	40	•	•	•		•		•	•	•	•		✓
Terra Cotta	0.36	39	•	•					•	•		•		✓
<b>Low Gloss Colors</b>														
Granite	0.32	33	•	•	•				•	•	•	•		✓
<b>Metallics</b>														
Aged Copper	0.26	25		•					•	•				✓
Champagne	0.40	42		•					•	•	•	•		✓
Copper Penny	0.47	53	•	•					•	•	•	•		✓
Silver	0.49	54	•	•	•				•	•	•	•		✓
Weathered Zinc	0.26	23	•	•	•				•	•		•		✓
Zinc*	0.33	35	•	•					•	•	•	•		✓
<b>Exotics - 10-year Color Fade Warranty</b>														
Award Blue (10-YR)*	0.21	17	•	•						•		•		
Cardinal Red (10-YR)*	0.37	39	•	•					•	•		•		✓
<b>Bare Products</b>														
Drexlume™			•	•	•	•	•	•						
Mill Finished Aluminum										•	•	•	•	
Clear Anodized										•	•	•	•	
Dark Bronze Anodized										•	•	•	•	
Black Anodized											•	•	•	
Vintage®			•	•										
Urban Slate			•	•										
HDG G90			• 16ga x 48" x 120" • 18 ga x 48" x 120" • 20 ga x 48" x 120" • 22 ga x 48" x 120"											

- High-performance painted metal roofing and perimeter edge products.
- Standard sheets come in 48" x 120".
- 35-year paint warranty on Galvalume® and Aluminum substrates, excluding Exotics. Ask about our Gold Standard Warranty.
- 25-year warranty on Drexlume™.

- Not all colors and gauges are stocked in all locations. Contact your local sales rep for specific stocking information and special requests including 22" coils, and custom gauges and widths.
- Custom colors available.
- Oil canning is not a cause for rejection.

**SHERWIN-WILLIAMS.**  
Coil Coatings