



Architectural Canopy Cantilever

PRODUCT INFORMATION

Experience excellence with our top-quality extruded aluminum canopies. Minimalistic design for unobstructed coverage, creating a spacious and inviting building entry.



Architectural Canopy Cantilever

TECHNICAL DATA

Most Extruded Aluminum (T6-6063)

Fascia .125"

Deflection rating L/180.

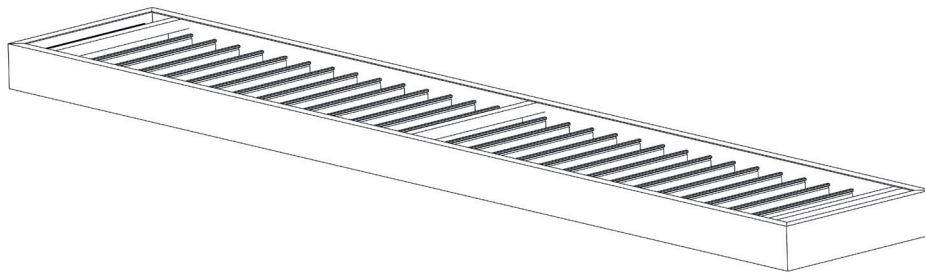

GUTTER FASCIA

Fascia Options

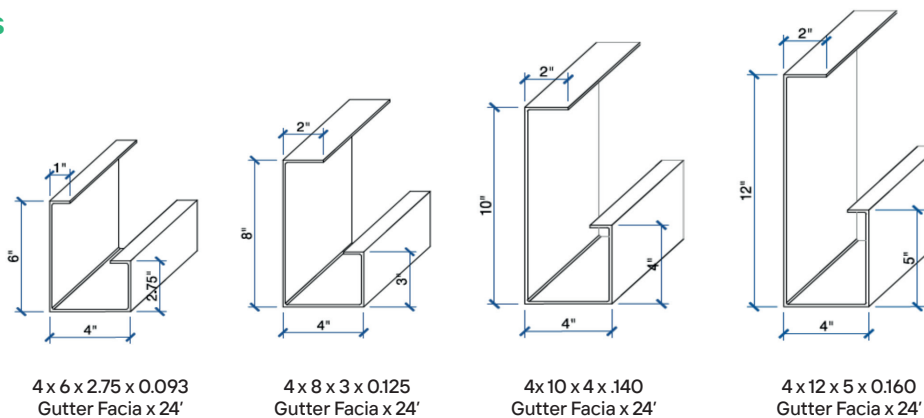

FLAT SOFFIT DECKING

Decking consists in interlocking extruded aluminum members with mechanical fasteners field applied to provide structural integrity for the completed assembly.

Front View

Top View

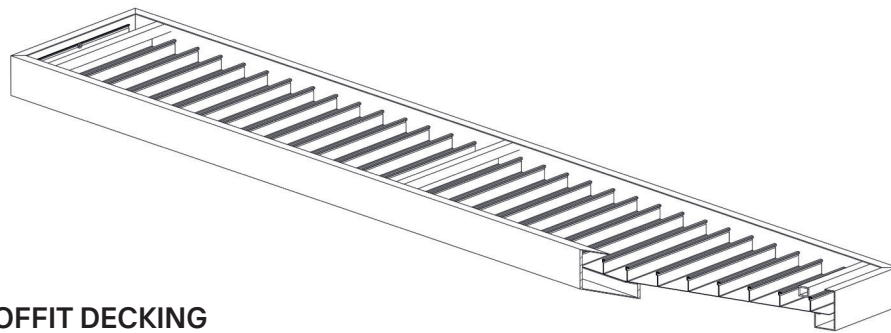
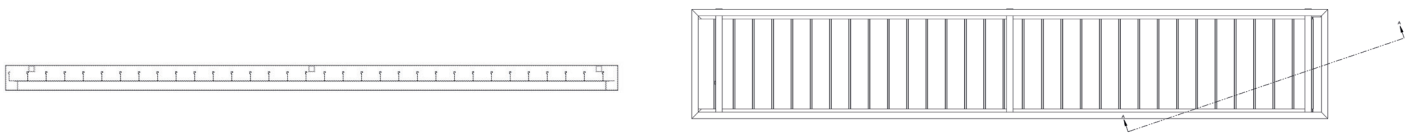

FLAT SOFFIT DECKING

Deck Options

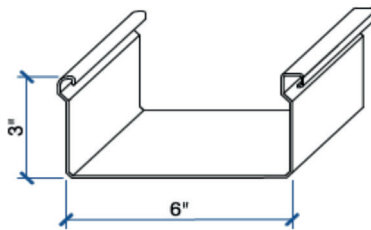

3 x 6 x 0.065 Self Mating
Canopy Roof Pan x 24'

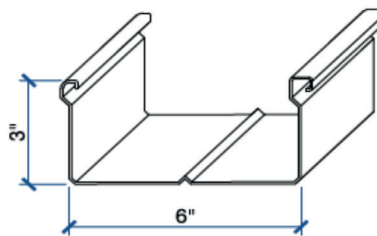

3 x 6 x 0.078 Self Mating
Canopy Roof Pan (V-Deck)

SUPPORT SYSTEM

Connections are mechanically assembled utilizing 3/16" fasteners with a minimum shear stress of 350 lb.

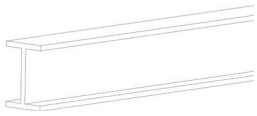

S3 x 5.7# Structural Steel S-Beam

ASTM A36 grade material.
Weight of the beam is 5.7 pounds per foot.
The flange is 2.60" wide.
The web is 0.17" thick at the thinnest point

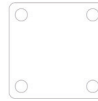

7" x 8" x 1/2" Steel Plates

ASTM A36 grade material.
High quality laser cut hot rolled mild steel



CONCEALED DRAINAGE

Water will drain from covered surfaces into the integral fascia gutter and be directed to either the front or the rear for discharge via its designated downspout.

